

# Cavity Slider Pocket Frame (2'10"x7'6")

**FOR DOORS** Frame & Jamb Dimensions

(888) 466 0030  
[www.cavitysliders.com](http://www.cavitysliders.com)



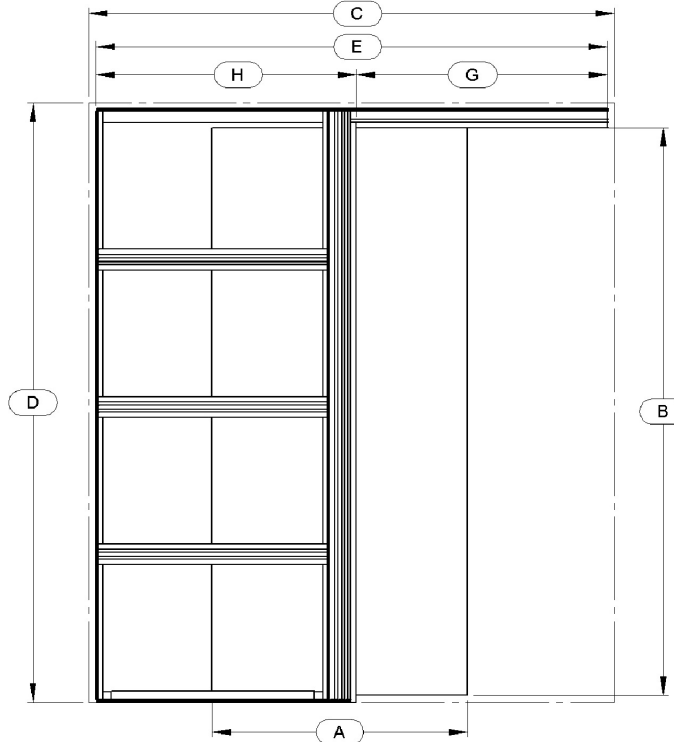
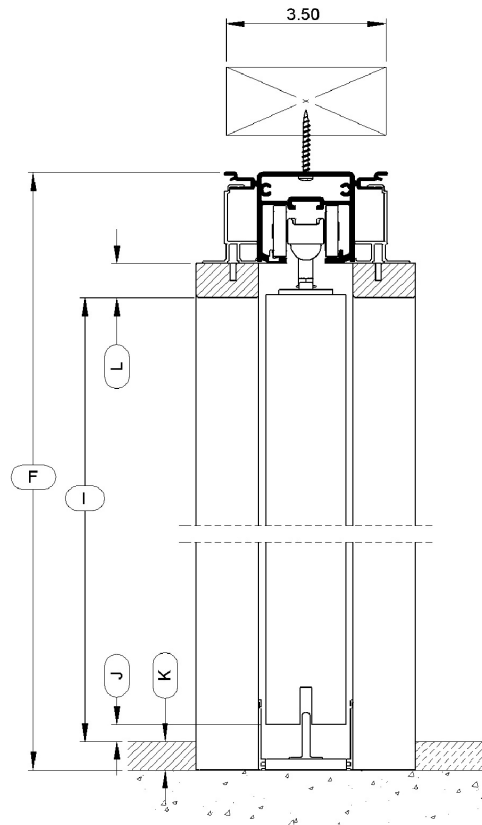

Item: CSSKNSSHD

CAVITY SLIDER SINGLE NSS HD 4"  
 STUD KITSET CAVITY

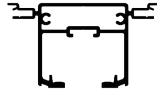
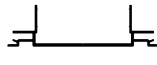
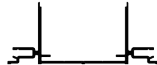
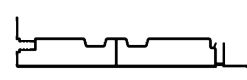

Front Elevation

### Extrusion Cut Lengths

	<b>Track Length:</b> 68"
	<b>Back Stud Length:</b> 92 15/16"
	<b>Bottom Plate Length:</b> 33 7/8"
	<b>Split Jamb Length:</b> 92 11/16"
	<b>Slat Length:</b> 28 7/16"
	<b>Top Fixing Length:</b> 34 1/8"
	<b>Bottom Fixing Length:</b> 24 15/16"

*Note: Drawing not to scale*

*All units shown are in inches*

**Please check & approve drawing**

Sign ..... Date .....

*The information contained in this drawing is the sole property of Cavity Sliders Ltd. Any reproduction, disclosure or use of this document, without the written permission of Cavity Sliders Ltd, is strictly prohibited.*

<b>A.</b> Door Width: 34"	<b>G.</b> Clear Opening to End of Track: 33 3/8"	<b>K.</b> Floor Thickness: 1/2"
<b>B.</b> Door Height: 90"	<b>H.</b> Pocket Depth: 34 45/64"	<b>L.</b> Jamb Thickness: 3/4"
<b>C.</b> RO Width: 70"	<b>I.</b> Finished Floor to Underside of Head: 90 7/16"	<b>M.</b> Protrusion: 0"
<b>D.</b> RO Height: 94 1/4"	<b>J.</b> Finished Floor Under Door Clearance: 1/2"	Underside of Track to Top of Door Clearance: 11/16"
<b>E.</b> Frame Width: 68 5/64"		
<b>F.</b> Frame Height: 93 11/16"		