

CS Cavity Slider Pocket Frame 2'10"x6'8"

FOR DOORS Frame & Jamb Dimensions

(888) 466 0030
www.cavitysliders.com

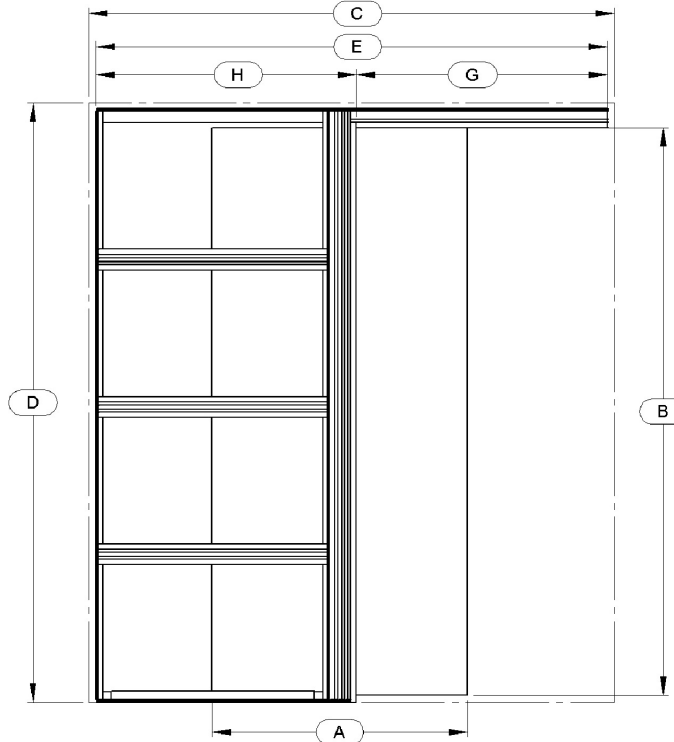
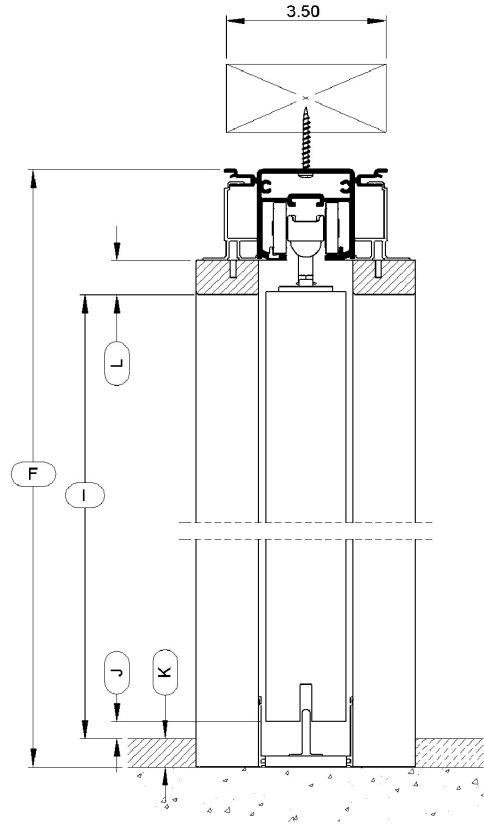

Item: CSS4K21068

CAVITY SLIDER SINGLE NSS 4"
 STUD KITSET CAVITY SL

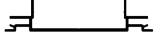
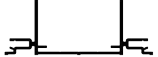
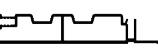
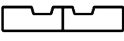

Front Elevation

Extrusion Cut Lengths

	Track Length: 68"
	Back Stud Length: 82 15/16"
	Bottom Plate Length: 33 7/8"
	Split Jamb Length: 82 11/16"
	Slat Length: 30"
	Top Fixing Length: 34 1/8"
	Bottom Fixing Length: 26 1/2"

Note: Drawing not to scale

All units shown are in inches

Please check & approve drawing

Sign Date

The information contained in this drawing is the sole property of Cavity Sliders Ltd. Any reproduction, disclosure or use of this document, without the written permission of Cavity Sliders Ltd, is strictly prohibited.

A. Door Width:	34"	G. Clear Opening to End of Track:	33 3/8"	K. Floor Thickness:	1/2"
B. Door Height:	80"	H. Pocket Depth:	34 45/64"	L. Jamb Thickness:	3/4"
C. RO Width:	70"	I. Finished Floor to Underside of Head:	80 7/16"	M. Protrusion:	0"
D. RO Height:	84 1/4"	J. Finished Floor Under Door Clearance:	1/2"	Underside of Track to Top of Door Clearance:	11/16"
E. Frame Width:	68 5/64"				
F. Frame Height:	83 11/16"				