





# CS Ultimate Cavity Slider Pocket Frame (3'6"x7'6")

**CavitySliders™**  
The Pocket Door Experts  
(888) 466 0030  
[www.cavitysliders.com](http://www.cavitysliders.com)

Item: CSU6K3676

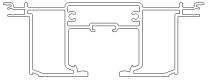
Cavity Slider Single Kit Set to suit a 2x6 (5 1/2") stud

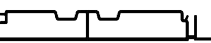
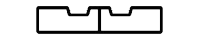
## Extrusion Cut Lengths

	<b>Track Length:</b> 84"
	<b>Back Stud Length:</b> 92 15/16"
	<b>Bottom Plate Length:</b> 41 7/8"
	<b>Split Jamb Length:</b> 92 11/16"
	<b>Slat Length:</b> 36 7/16"
	<b>Top Fixing Length:</b> 42 1/8"
	<b>Bottom Fixing Length:</b> 32 15/16"

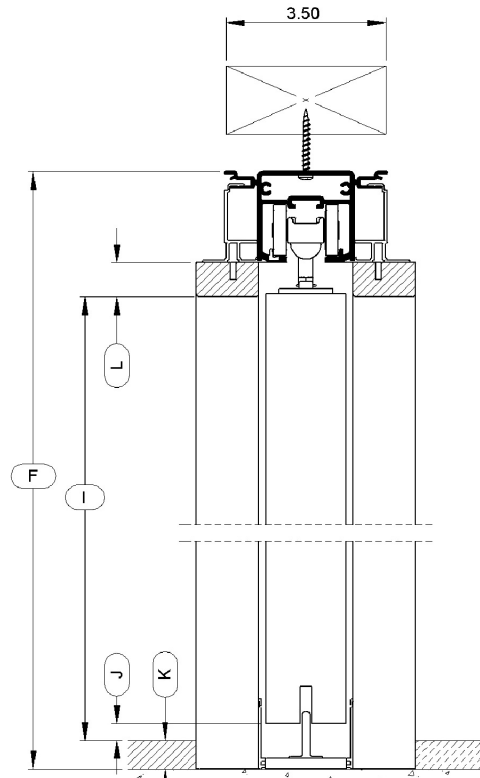

Details only for 2x4 frame

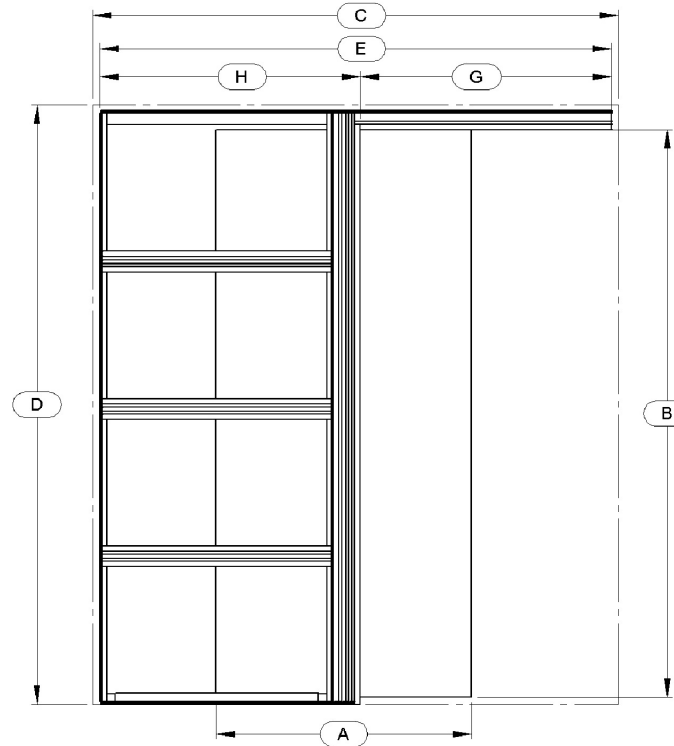

Front Elevation



<b>A. Door Width:</b>	42"	<b>G. Clear Opening to End of Track:</b>	41 3/8"	<b>K. Floor Thickness:</b>	1/2"
<b>B. Door Height:</b>	90"	<b>H. Pocket Depth:</b>	42 45/64"	<b>L. Jamb Thickness:</b>	3/4"
<b>C. RO Width:</b>	86"	<b>I. Finished Floor to Underside of Head:</b>	90 7/16"	<b>M. Protrusion:</b>	0"
<b>D. RO Height:</b>	94 1/4"	<b>J. Finished Floor Under Door Clearance:</b>	1/2"	<b>Underside of Track to Top of Door Clearance:</b>	11/16"
<b>E. Frame Width:</b>	84 5/64"				
<b>F. Frame Height:</b>	93 11/16"				