





CS Ultimate Cavity Slider Pocket Frame (3'2"x7'6")

CavitySliders™
The Pocket Door Experts
(888) 466 0030
www.cavitysliders.com

Item: CSU6K3276

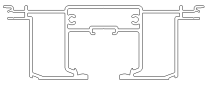
Cavity Slider Single Kit Set to suit a 2x6 (5 1/2") stud

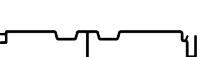
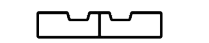
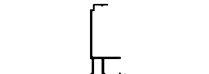
Extrusion Cut Lengths

	Track Length: 76"
	Back Stud Length: 92 15/16"
	Bottom Plate Length: 37 7/8"
	Split Jamb Length: 92 11/16"
	Slat Length: 32 7/16"
	Top Fixing Length: 38 1/8"
	Bottom Fixing Length: 28 15/16"

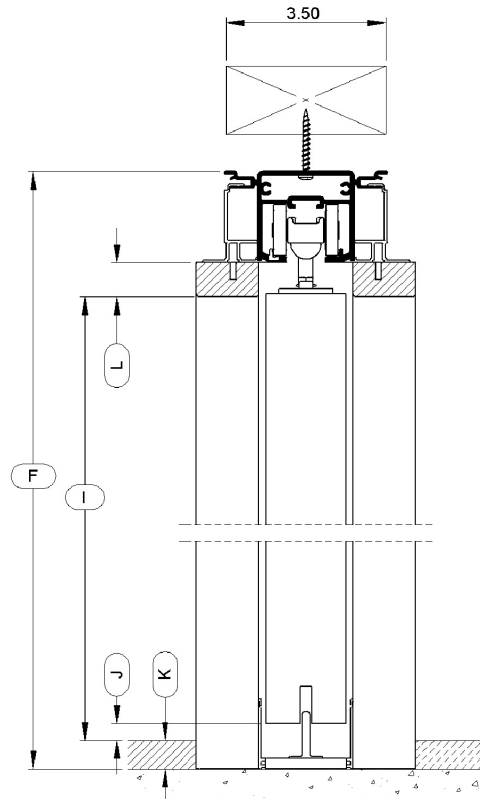

Details only for 2x4 frame

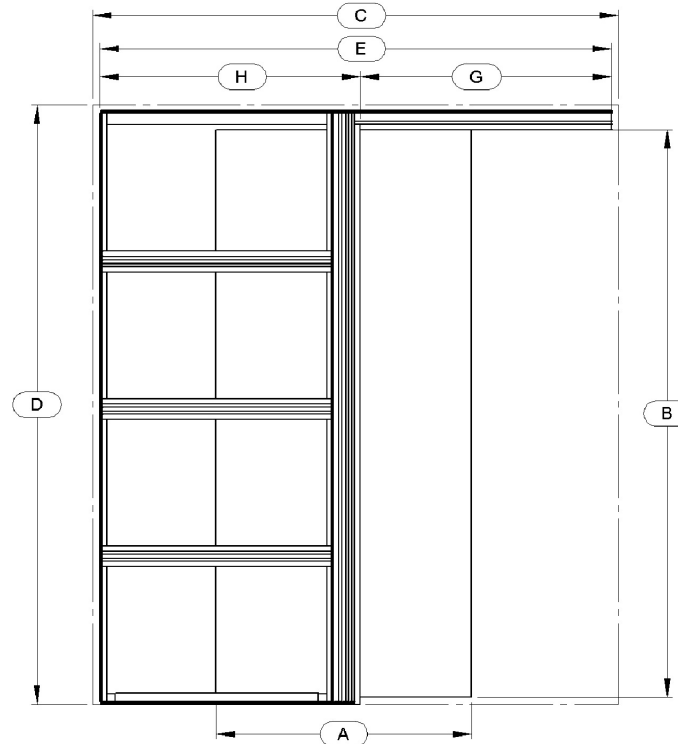

Front Elevation



A. Door Width:	38"	G. Clear Opening to End of Track:	37 3/8"	K. Floor Thickness:	1/2"
B. Door Height:	90"	H. Pocket Depth:	38 45/64"	L. Jamb Thickness:	3/4"
C. RO Width:	78"	I. Finished Floor to Underside of Head:	90 7/16"	M. Protrusion:	0"
D. RO Height:	94 1/4"	J. Finished Floor Under Door Clearance:	1/2"	Underside of Track to Top of Door Clearance:	11/16"
E. Frame Width:	76 5/64"				
F. Frame Height:	93 11/16"				