

# CS Ultimate Cavity Slider Pocket Frame (2'4"x7'6")

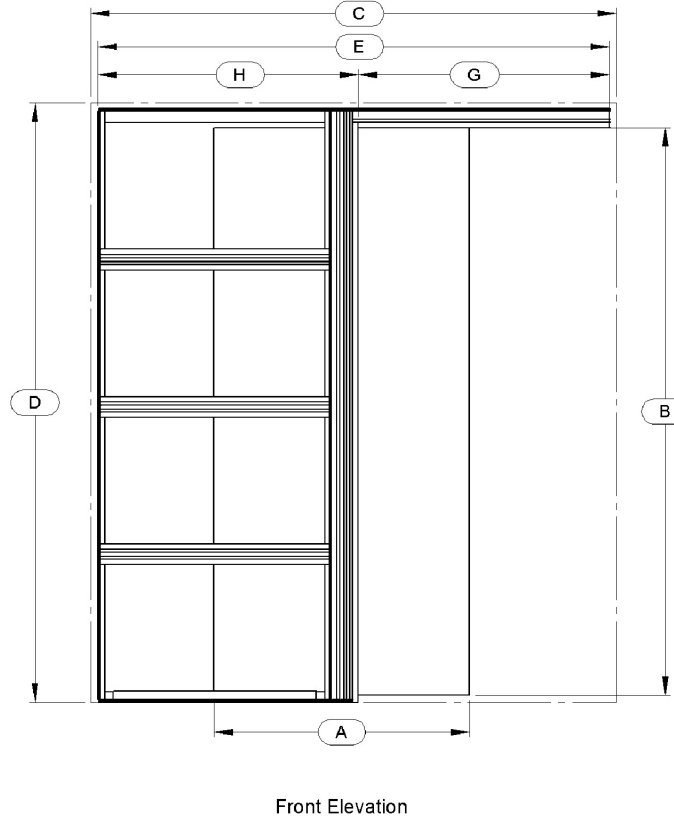

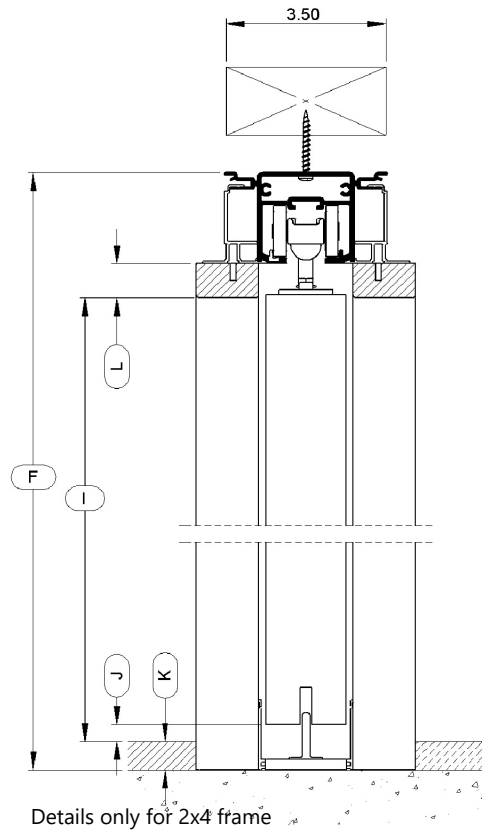

**CavitySliders™**  
The Pocket Door Experts  
(888) 466 0030  
[www.cavitysliders.com](http://www.cavitysliders.com)

Item: CSU6K2476

Cavity Slider Single Kit Set to suit a 2x6 (5 1/2") stud

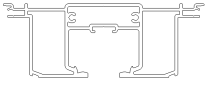

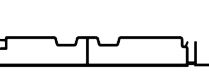
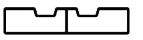
### Extrusion Cut Lengths

	<b>Track Length:</b> 56"
	<b>Back Stud Length:</b> 92 15/16"
	<b>Bottom Plate Length:</b> 27 7/8"
	<b>Split Jamb Length:</b> 92 11/16"
	<b>Slat Length:</b> 22 7/16"
	<b>Top Fixing Length:</b> 28 1/8"
	<b>Bottom Fixing Length:</b> 18 15/16"



<b>A. Door Width:</b>	28"	<b>G. Clear Opening to End of Track:</b>	27 3/8"	<b>K. Floor Thickness:</b>	1/2"
<b>B. Door Height:</b>	90"	<b>H. Pocket Depth:</b>	28 45/64"	<b>L. Jamb Thickness:</b>	3/4"
<b>C. RO Width:</b>	58"	<b>I. Finished Floor to Underside of Head:</b>	90 7/16"	<b>M. Protrusion:</b>	0"
<b>D. RO Height:</b>	94 1/4"	<b>J. Finished Floor Under Door Clearance:</b>	1/2"	<b>Underside of Track to Top of Door Clearance:</b>	11/16"
<b>E. Frame Width:</b>	56 5/64"				
<b>F. Frame Height:</b>	93 11/16"				