

CS Ultimate Cavity Slider Pocket Frame 2'2" x 7'0"

CavitySliders™
The Pocket Door Experts
(888) 466 0030
www.cavitysliders.com

Item: CSU6K2270

Cavity Slider Single Kit Set to suit a 2x6 (5 1/2") stud

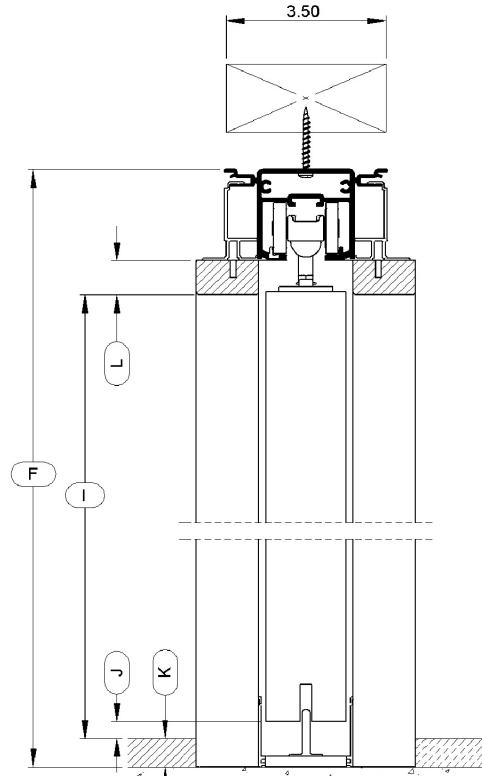



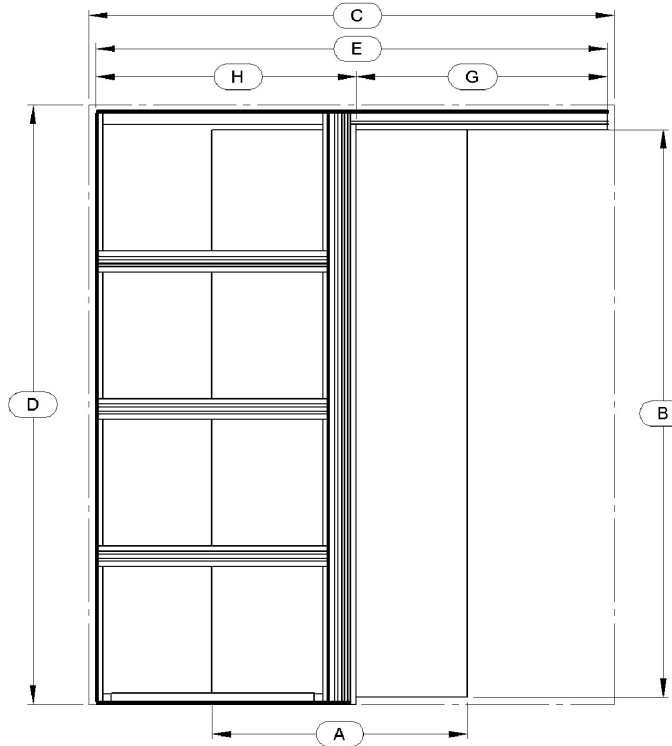



Details only for 2x4 frame

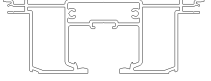

Front Elevation

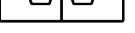
Extrusion Cut Lengths

	Track Length: 52"
	Back Stud Length: 86 15/16"
	Bottom Plate Length: 25 7/8"
	Split Jamb Length: 86 11/16"
	Slat Length: 20 7/16"
	Top Fixing Length: 26 1/8"
	Bottom Fixing Length: 16 15/16"



A. Door Width:	26"	G. Clear Opening to End of Track:	25 3/8"	K. Floor Thickness:	1/2"
B. Door Height:	84"	H. Pocket Depth:	26 45/64"	L. Jamb Thickness:	3/4"
C. RO Width:	54"	I. Finished Floor to Underside of Head:	84 7/16"	M. Protrusion:	0"
D. RO Height:	88 1/4"	J. Finished Floor Under Door Clearance:	1/2"	Underside of Track to Top of Door Clearance:	11/16"
E. Frame Width:	52 5/64"				
F. Frame Height:	87 11/16"				