

# CS Ultimate Cavity Slider Pocket Frame 2'10"x7'0"

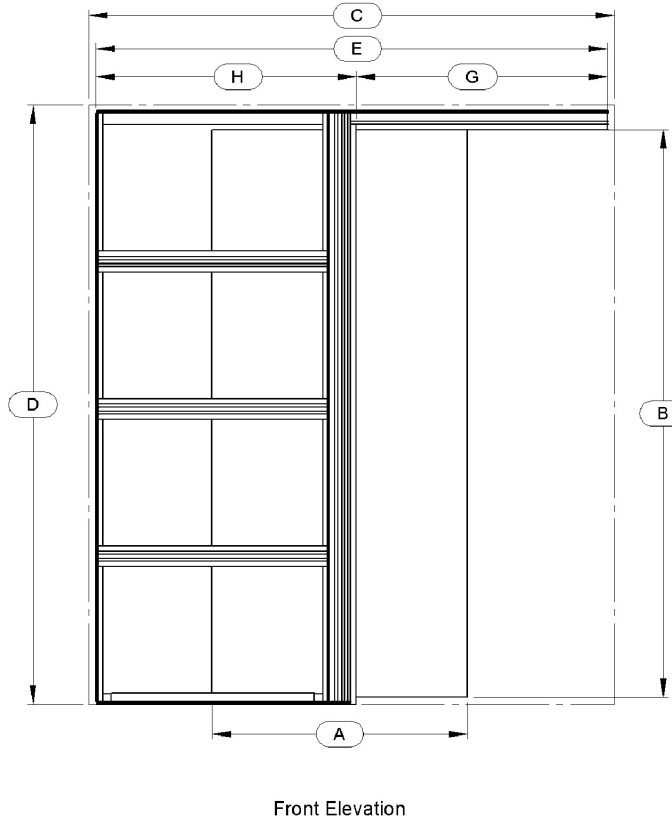

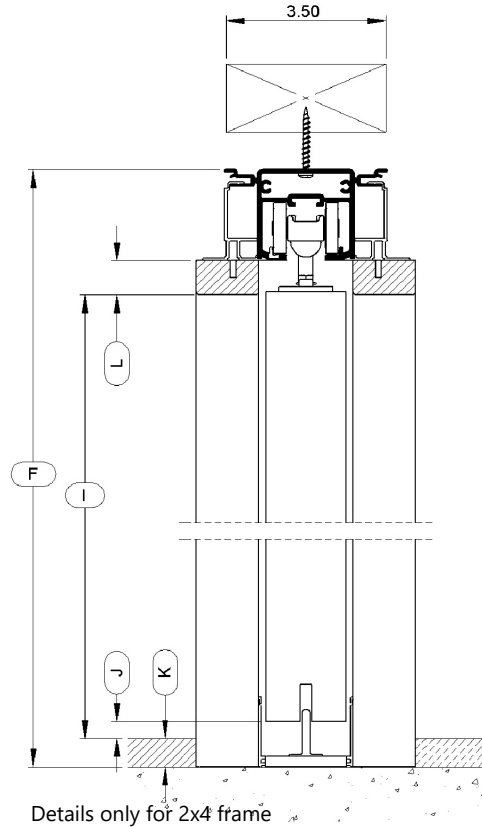

**CavitySliders™**  
The Pocket Door Experts  
(888) 466 0030  
[www.cavitysliders.com](http://www.cavitysliders.com)

Item: CSU6K21070

Cavity Slider Single Kit Set to suit a 2x6 (5 1/2") stud

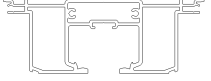

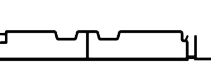
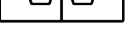
## Extrusion Cut Lengths

|   |   |
|---|---|
|    | <b>Track Length:</b><br>68"               |
|    | <b>Back Stud Length:</b><br>86 15/16"     |
|    | <b>Bottom Plate Length:</b><br>33 7/8"    |
|    | <b>Split Jamb Length:</b><br>86 11/16"    |
|    | <b>Slat Length:</b><br>28 7/16"           |
|   | <b>Top Fixing Length:</b><br>34 1/8"      |
|  | <b>Bottom Fixing Length:</b><br>24 15/16" |



|                         |           |  |           |   |        |
|-------------------------|-----------|--|-----------|---|--------|
| <b>A. Door Width:</b>   | 34"       | <b>G. Clear Opening to End of Track:</b>       | 33 3/8"   | <b>K. Floor Thickness:</b>                          | 1/2"   |
| <b>B. Door Height:</b>  | 84"       | <b>H. Pocket Depth:</b>                        | 34 45/64" | <b>L. Jamb Thickness:</b>                           | 3/4"   |
| <b>C. RO Width:</b>     | 70"       | <b>I. Finished Floor to Underside of Head:</b> | 84 7/16"  | <b>M. Protrusion:</b>                               | 0"     |
| <b>D. RO Height:</b>    | 88 1/4"   | <b>J. Finished Floor Under Door Clearance:</b> | 1/2"      | <b>Underside of Track to Top of Door Clearance:</b> | 11/16" |
| <b>E. Frame Width:</b>  | 68 5/64"  |  |           |   |        |
| <b>F. Frame Height:</b> | 87 11/16" |  |           |   |        |